

502 35100

量測原理與機工實驗

IV. Laser Diagnostics for Thermofluid Measurements

Instructor: Kuo-Long Pan

潘國隆

Department of Mechanical Engineering
National Taiwan University
June 6, 2012

1

Course Content of Lecture III

- Introduction to Laser
 - Background and principle
 - Components
 - Types
 - Illumination techniques
 - LDV for velocity measurement
 - Background and principle
 - Components
 - Types
 - Examples
 - PDPA for measurements of velocity and particle size
 - Principle
 - Components
 - A study of measuring flow velocity and species
 - Measurements of temperature and species concentration
 - Mie scattering
 - Rayleigh scattering
 - Raman scattering
 - CARS
 - LIFS
- References :
- R. J. Goldstein, *Fluid Mechanics Measurements*, Hemisphere, 1983
- S. Tavoularis, *Measurement in Fluid Mechanics*, Cambridge Univ., 2005
- A. C. Eckbreth, *Laser Diagnostics for Combustion Temperature and Species*, Abacus Press, 1988

2

Introduction to Laser

- Acronym: light amplification by stimulated emission of radiation
- Advantages as compared with thermal light sources
 - Coherent (with all light fronts in phase)
 - Collimated and concentrated (essentially parallel, with a small cross-sectional area)
 - Monochromatic (with spectral energy concentrated in one or more extremely narrow bands)
- Disadvantages
 - Diffraction due to dust particles → *speckles*: distortion by fringes and patterns; partly removed by a pinhole (spatial filter)

3

- Principle
 - Active medium: gas, crystal, semiconductor, liquid solution ...
 - Medium composed of particles (atoms, ions, or molecules), with electrons existing only at specific quantized energy levels
 - *absorption* and *spontaneous emission*: random direction
 - *stimulated emission*: coherent emission of an incident photon, with identical frequency (energy), phase, and direction
 - *population inversion*: for effective stimulated emission, larger population of atoms at a high energy state than at a lower state
- Use (nonintrusive): flow visualization, measurements for velocity, pressure, temperature, and composition, both in liquids and gases

4

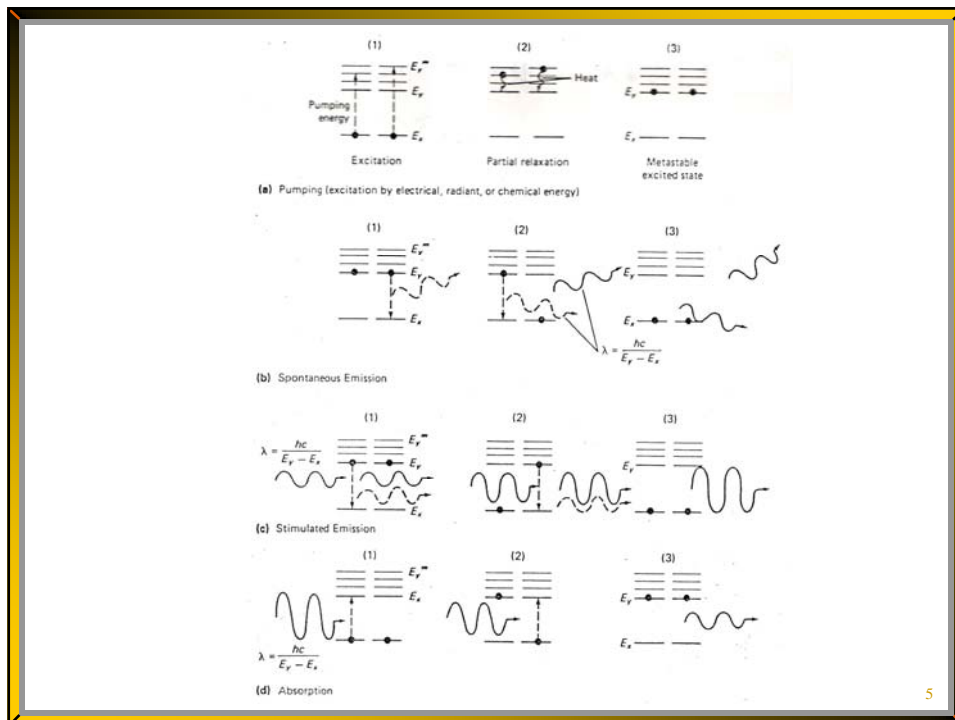

5

▪ Components

- Energy pump source: in the form of electromagnetic or chemical energy provided by an electric discharge, a flash lamp, or another laser

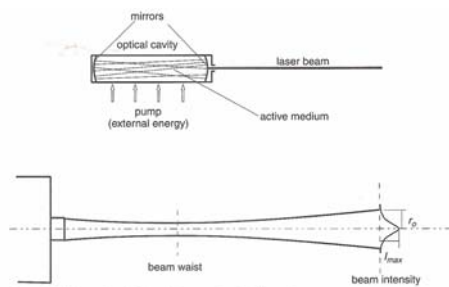

Figure 5.7. Schematics of a basic laser and a typical laser beam.

Photocopied from Tavoularis (2005)

- Optical cavity: a tube with two plane or concave mirrors at the ends
 - Standing waves: distance between two mirrors being adjusted to an integral multiple of light wavelength $\lambda/2$
 - One of the mirrors being slightly transparent

6

▪ Quality factor (Q) and Q-switching

- Q : energy decay, high better
- Produce large laser pulses

▪ Modes of standing waves

- Longitudinal mode
 - Multiples of $\lambda/2$
 - Adjust distance between mirrors

• Transverse mode $I_a(r) = I_{a,max} e^{-2(2r/d_e)^2}$

- Fundamental mode ~ Gaussian
- $d_e \sim$ circle with $e^{-2} I_{a,max} \approx 13.5\% I_{a,max}$

- Preferred due to smallest beam divergence, diameter, and spatial coherency though with lower power

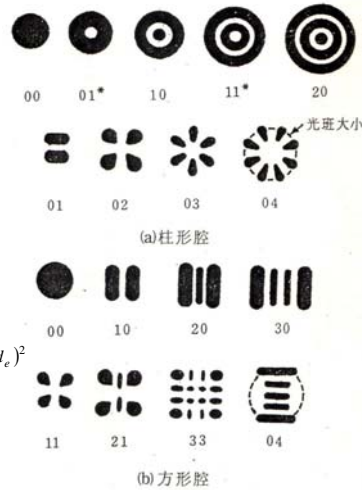

7

▪ Laser types: continuous wave (CW) type, single pulse, repetitive pulses

• *Solid-state* lasers:

- broad and effective absorption band, high fluorescence efficiency, long life, narrow fluorescence band of wavelength
- population inversion, stimulated emission
- Ex. Ruby laser: $\text{Al}_2\text{O}_3:\text{Cr}^{3+}$, Nd:YAG laser: $\text{Y}_3\text{Al}_5\text{O}_{12}:\text{Nd}^{3+}$ (Neodymium doped Yttrium Garnet Laser 釹玻璃雷射, 釹玻璃+釹鋁石榴石晶體)

• *Gas* lasers:

- atomic: He, Ne, Ar, Kr, Xe
- molecular: CO_2 , CO, N_2 , H_2 , HF
- ionic: Ar^+ , Kr^+ , Cd metallic ion

• *Semiconductor* lasers: GaAs

• *Liquid* lasers:

- organic dye solution: broad spectrum, tunable
- inorganic liquid: $\text{SeOCl}_2:\text{Nd}^{3+}$, $\text{POCl}_3:\text{Nd}^{3+}$

8

▪ Laser types (Cont'd)

- *Helium-neon* (He-Ne) lasers: CW type, power 0.3 – 15 mW, at $\lambda = 633$ nm (red)
 - easy operation and low cost, flow visualization
 - active medium composed of helium and neon atoms
 - energy pump source of high-voltage (~ 2000 V) electric field
- *Argon-ion* (Ar) lasers: CW type, power 100 mW – 10 W, at 7 wavelengths particularly $\lambda = 488$ (blue) and 514.5 nm (green)
 - low power efficiency, water/air cooling
 - for flow visualization, LDV, PDPA, PIV ...
 - active medium of argon atoms, at ion state with collision by electrons accelerated via E field, in a plasma tube

9

- *Nd:YAG* lasers 鈹鈹鋁石榴石雷射: solid-state pulsed lasers
 - active medium of neodymium (Nd^{+3}) as an impurity into a crystal of yttrium aluminum garnet (YAG) serving as a host
 - energy pump source of a flash lamp
 - in a single pulse mode: pulses with energy 100 – 400 mJ and 100 ps – 10 ns, with Q -switch
 - main emission at $\lambda = 1064$ nm (infrared) but 532 nm available via frequency doubling or tripled in ultraviolet range with special crystal
 - give a train of pulses at repetition rates exceeding 1 kHz, with pumping provided by a CW diode laser
- *Copper-vapor* (Cu) lasers: repetitive pulses 15 – 60 ns, 10 mJ per pulse, 5 – 15 kHz, mainly at $\lambda = 510.6$ (green) and 578.2 nm (yellow)
 - unlike others with cooling, insulated to achieve high operating T
 - suitable for particle tracking, flow visualization, PIV ...

10

- *Dye* lasers: substance used for dyeing fabrics
 - active medium of complex, multi-atomic, organic molecules
 - continuous emission spectra over wide λ bands of 200 – 1500 nm
 - energy pump source of a flash lamp or other lasers
 - when pumped by a Nd:YAG laser, in combination with frequency filters contained in the optical cavity, tuned to emit radiation at narrow bands matching resonant frequencies of various molecules
 - for measurement of species concentration (gas mixtures, combustion...)
- *Excimer* lasers: e.g. KrF and XeCl, used specifically in combustion
 - active medium of diatomic molecules, whose atoms are bound attractively only if one of them is at an excited electronic state (exciplexes) but dissociate at the ground state
 - emit ultraviolet and high-energy pulses at high repetition rate

11

- CO_2 lasers:
 - active medium of CO_2 molecules at ground state
 - oscillate at $\lambda = 10.4 \mu\text{m}$ (infrared), either in continuous or pulsed mode
 - population inversion to higher vibrational energy states caused by collisions with nitrogen molecules at a metastable, excited vibrational mode; pumped thermally
- *Laser diodes*:
 - semiconductor devices that emit coherent radiation in visible or infrared ranges when current passes through
 - used extensively in optical-fiber communication systems, compact disc players, laser printers, remote controls, and intrusion detection systems
 - much smaller than conventional lasers and lower power requirement
 - high-power laser diodes used for flow visualization, LDV, PIV ...

12

▪ Illumination techniques

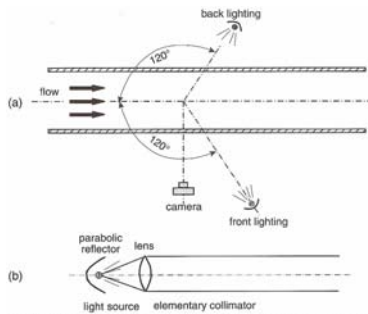

Figure 5.9. Sketches showing (a) optimal illumination arrangements and (b) an elementary light collimator.

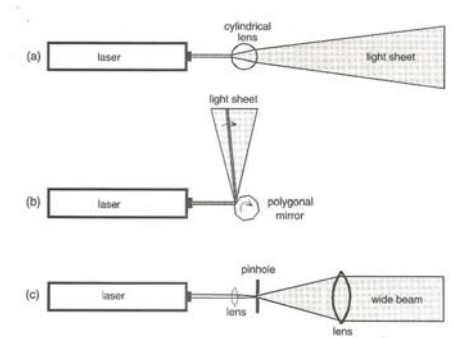

Figure 5.10. Conversion of a laser beam into (a) a light sheet with the use of a lens, (b) a light sheet with the use of a polygonal mirror, and (c) a wide beam.

Photocopied from Tavoularis (2005)

LDV for Velocity Measurement

- Acronym: laser Doppler velocimetry (LDV) or anemometry (LDA)
- Advantages as compared with conventional techniques
 - Non-intrusive, linear relation between flow velocity and Doppler frequency (no calibration and errors reduced), rapid response and high temporal resolution, high spatial resolution (1 mm³), large speed range, reversed flow, temperature insensitive
- Disadvantages
 - Transparent windows, seeding particles that follow flows (rate), complex alignment, not-so-easy signal processing with weak scattering light and interruption from different particles (low SNR)

- Basic principle

- Doppler shift of light frequency: *Doppler (-Fizeau) phenomenon*
- Doppler frequency: for a monochromatic, coherent, linearly polarized, and collimated laser beam

$$\nu_D = \frac{\vec{V} \cdot (\vec{e}_s - \vec{e}_i)}{\lambda} = \frac{2 \sin(\phi/2)}{\lambda} V_\phi$$

- generally not possible to measure $\nu_D \ll \nu$ unless for large V_ϕ
- $\nu \approx 10^{14}$ Hz

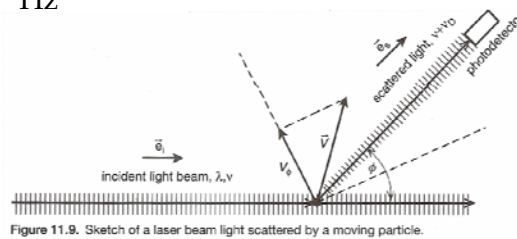

Photocopied from Tavoularis (2005)

15

- Dual-beam LDV: single component, forward scatter

- beam splitter: monochromatic, coherent, linearly polarized beam
- output voltage via a photodetector $E \sim A^2$

$$\begin{aligned} E &\sim \{A_1 \sin 2\pi[(\nu + \nu_{D1})t] + A_2 \sin 2\pi[(\nu + \nu_{D2})t]\}^2 \\ &= A_1^2 \sin^2 2\pi[(\nu + \nu_{D1})t] + A_2^2 \sin^2 2\pi[(\nu + \nu_{D2})t] \\ &\quad + A_1 A_2 \{\cos 2\pi[(\nu_{D1} - \nu_{D2})t] - \cos 2\pi[(2\nu + \nu_{D1} + \nu_{D2})t]\} \end{aligned}$$

- Doppler frequency

difference and signal

$$\nu'_D = \nu_{D1} - \nu_{D2}$$

$$E \sim a + b \cos 2\pi \nu'_D t$$

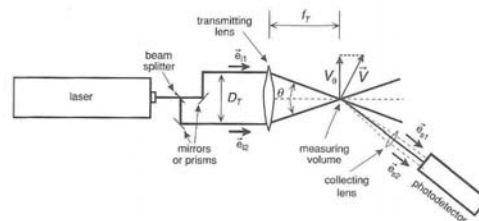

Figure 11.10. Sketch of the dual-beam laser Doppler configuration.

Photocopied from Tavoularis (2005)

16

- Doppler frequency difference

$$v'_D = \frac{\vec{V} \cdot (\vec{e}_{s1} - \vec{e}_{i1})}{\lambda} - \frac{\vec{V} \cdot (\vec{e}_{s2} - \vec{e}_{i2})}{\lambda}$$

$$= \frac{\vec{V} \cdot (\vec{e}_{i2} - \vec{e}_{i1})}{\lambda} = \frac{2 \sin(\theta/2)}{\lambda} V_\theta \quad V_\theta = \frac{\lambda}{2 \sin(\theta/2)} v'_D$$

- Measuring volume and fringe model

Focused beam diameter

$$d_{fe} \cong \frac{4 f_T \lambda}{\pi \alpha_e}$$

$$h = \frac{d_{fe}}{\cos(\theta/2)} \quad l = \frac{d_{fe}}{\sin(\theta/2)}$$

$$\text{measuring volume} \rightarrow \frac{\pi d_{fe}^3}{6 \cos(\theta/2) \sin(\theta/2)}$$

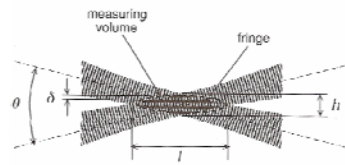

Figure 11.11. Measuring volume and fringe pattern in the dual-beam configuration.

- Fringe spacing $\delta = \frac{\lambda}{2 \sin(\theta/2)}$
and crossing frequency V_θ/δ

Photocopied from Tavoularis (2005)

▪ More on LDV working principles

• Doppler shift of light frequency

- Frequency observed by a particle

$$f_p = \frac{c - \mathbf{u} \cdot \mathbf{l}}{\lambda} = f \left(1 - \frac{\mathbf{u} \cdot \mathbf{l}}{c} \right) \quad \mathbf{l} = -\ell$$

- Frequency observed by detector

$$\lambda_A = \frac{c - \mathbf{u} \cdot \mathbf{k}}{f_p} \rightarrow f_A = \frac{c}{\lambda_A} = \frac{f \left(1 - \frac{\mathbf{u} \cdot \mathbf{l}}{c} \right)}{1 - \frac{\mathbf{u} \cdot \mathbf{k}}{c}}$$

$$\Delta f = f_A - f = \frac{\mathbf{u} \cdot (\mathbf{k} - \mathbf{l})}{\lambda \left(1 - \frac{\mathbf{u} \cdot \mathbf{k}}{c} \right)}$$

$$\Delta f \sim \frac{1}{\lambda} \mathbf{u} \cdot (\mathbf{k} - \mathbf{l}) \quad c \gg u$$

Photocopied from 黃清白, 楊鏡堂, 科儀新知, 第十一卷, 第六期 79.5



圖1. 都卜勒效應。
(a)入射光束、散射光束及流速各個向量
(b)因移動觀測者而引起的都卜勒效應
(c)因移動光源而引起的都卜勒效應

• LDV (TSI) dual beam

- Intensity measured by a photodetector

$$A = A_1 \cos(2\pi f_1 t + \phi_1)$$

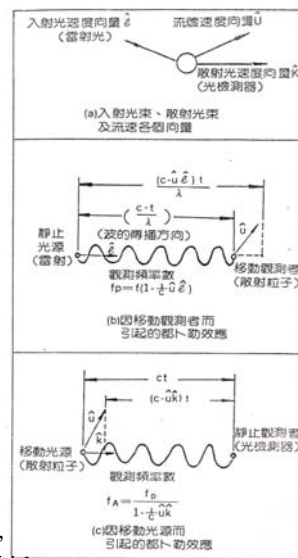
$$A' = A_2 \cos(2\pi f_2 t + \phi_2)$$

$$I = B(A + A')^2$$

$$\rightarrow I = B \left\{ \begin{array}{l} \frac{1}{2}(A_1^2 + A_2^2) + \\ A_1 A_2 \cos[2\pi(f_1 - f_2)t + (\phi_1 - \phi_2)] \end{array} \right\}$$

- Set $\phi_1 - \phi_2 = 0 \rightarrow$ Optical Heterodyning

(光外差檢測法)

Photocopied from 黃清白, 楊鏡堂, 科儀新知, 第十一卷, 第六期 79.5



圖3. 雙光束干涉型雷射測速儀。



圖2. 兩個頻率的外差。訊號(a)與(b)相加形成脈波(c), 經過整流後成為拍訊號(d)。

19

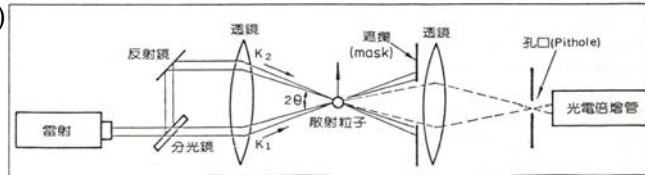
- Doppler frequency

$$f_D = f_1 - f_2 = \frac{f[(1 - \mathbf{u} \cdot \mathbf{l}_1/c) - (1 - \mathbf{u} \cdot \mathbf{l}_2/c)]}{1 - \mathbf{u} \cdot \mathbf{k}/c}$$

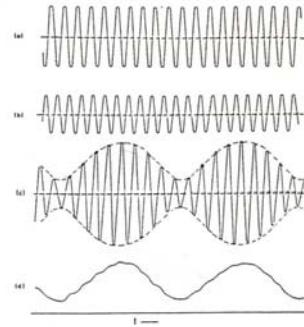
$$\xrightarrow{u \ll c} f_D = \frac{f \mathbf{u} \cdot (\mathbf{l}_2 - \mathbf{l}_1)}{c} = \frac{2|u| \sin \theta}{\lambda}$$

- Pros & cons: independent of \mathbf{k} , capable of receiving scattered light beam in any direction, large receiver diameter to get clear signal; finite measuring volume for sufficient fringes, no two particles simultaneously and hence low particle concentration.



圖3. 雙光束干涉型雷射測速儀。

20

- Beam expansion
 - to reduce the size of the measuring volume
 - improve spatial resolution of velocity measurement and amplitude resolution (light power density \uparrow)
 - beam diameter $d_{ex} = E_x d_e$, beam expansion ratio $E_x > 1$

$$d_{fex} = \frac{d_{fe}}{E_x} \cong \frac{4f_T \lambda}{\pi d_{ex}}$$

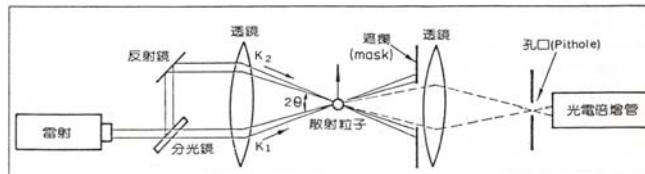
- Frequency shifting
 - $V_f = \Delta v \delta$
 - $V_\theta = (v'_D - \Delta v) \delta$
 - Bragg cell: acousto-optic device
 - for judgment of flow direction

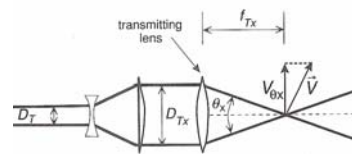

Photocopied from Tavoularis (2005)

- Multicomponent and multipoint systems
 - Two-component system: two pairs of beams (simply three beams)
 - Two-color LDV: two lasers or single with multiple spectral peaks, e.g. Ar-ion laser with λ of 514.5 and 488 nm; measurements of joint statistical properties such as covariance (Reynolds shear stress) ...
 - Three-component system (another λ of 476.5 nm or from a different type of laser): coordinate transformation may be needed.
 - Multipoint measurement: spatial correlations and wavenumber spectra in different directions;
 - usually two LDV systems
 - at most ...

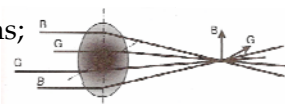

Figure 11.14. Sketch of a two-component LDV configuration with two pairs of beams at orthogonal planes; the letters G and B indicate beams with light at the green and the blue spectral peaks of an Ar-ion laser, as well as the corresponding measured velocity components.

Photocopied from Tavoularis (2005)

- Doppler signal

- *pedestal*: Gaussian distribution of light intensity

- *burst*: fringe crossing by particles in the measuring volume with amplitude modulated oscillatory function of v'_D

- burst signal \sim size and refractive index of particles, position, path

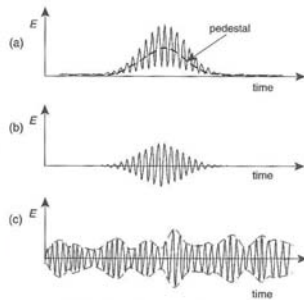

- accuracy (high burst density) \sim ambiguity noise and phase noise

- Other types

- *reference beam*

- *two-scattered beam*

Photocopied from Tavoularis (2005)

Figure 11.13. Typical Doppler signals (a) of a single particle, (b) of a single particle with the pedestal removed, and (c) of multiple particles with the pedestal removed.

- An example: TSI LDV dual-beam system

- Doppler shift of light frequency

- Beam source: laser, collimator, polarization (for beam splitter)

- Color Burst: Bragg cell (frequency), dispersion prism (color)

- Color Link: photomultiplier tube (PMT), high voltage power supply, frequency shifter, A/O oscillator

- 1990c processor

- FIND software

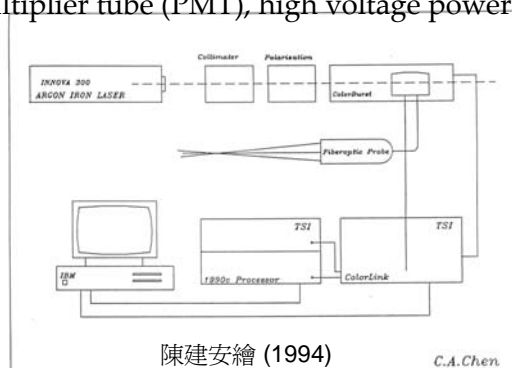

陳建安繪 (1994)

C.A.Chen

PDPA for Particle Measurement

- Acronym: phase Doppler particle analyzer (PDPA or PDA)
- Simultaneous measurement of flow velocity and size distribution
 - Mie scattering: light reflected or refracted through → phase shift
 - Determine phase shifts between Doppler signals of different detectors + geometrical arrangement, λ , optical parameters → D
- Pros and cons (types...)
 - Irrelevant to multiple scattering and absorption
 - Single particle in measuring volume → low concentration
 - Suitable only for optically homogeneous, spherical particles

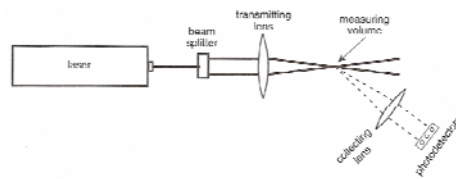
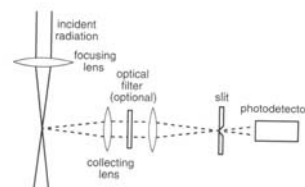

Figure 13.8. Sketch of a phase Doppler particle analyzer.

25

Measurement of Temperature and Species Concentration

- Background
 - Quantum mechanics/atomic & molecular physics
 - Elastic/inelastic scattering/absorption/nonlinear optical process
- Light-scattering method
 - Small measuring volume $\leq 1 \text{ mm}^3$
 - Spatial filter using a slit or pinhole
 - Right-angle collection but not line-of-sight methods (~ in situ absorption and emission spectroscopy): local but not path-average
 - Planar light-scattering methods



Photocopied from Tavoularis (2005)

26

- Mie scattering
 - Elastic scattering of light quanta from particulate matter
 - Basic effect underlying particle sizing, LDV, differential absorption backscattering ~ local concentration of particles
 - Accuracy affected by particle size (polydispersity), refractive index, particle coagulation, and absorption; not specific to species
- Molecular radiation emission
 - Radiation scattering at the molecular level
 - Identification of species and concentration
 - $I_{nm} = A_{nm} N_n h \nu_{nm}$, where A_{nm} is *Einstein transition probability*
 - High-power radiation sources and careful experimental setting

27

- Rayleigh scattering
 - Elastic scattering from isolated atoms and ordinary molecules:
 $D/\lambda \ll 1$ ($< 1/15$) ~ limit of Mie scattering
 - Sky colors ← *Rayleigh scattering cross section* $\sigma_R = \sigma_T (\lambda_0/\lambda)^4$
where *Thomson-scattering cross section* for a single electron $\sigma_T = 6.65 \times 10^{-29} \text{ m}^2$, and λ_0 the characteristic wavelength of an atom
 - Interfered by Mie scattering ~ clean condition, strong signal ...
 - Not specific to species; continuous signal, temporal resolution
 - Measurement for total density, temperature (const. P , spectra)
 - Different from Mie scattering in which many atoms/molecules gather and EM waves interfere (no lateral scattering, directional)

28

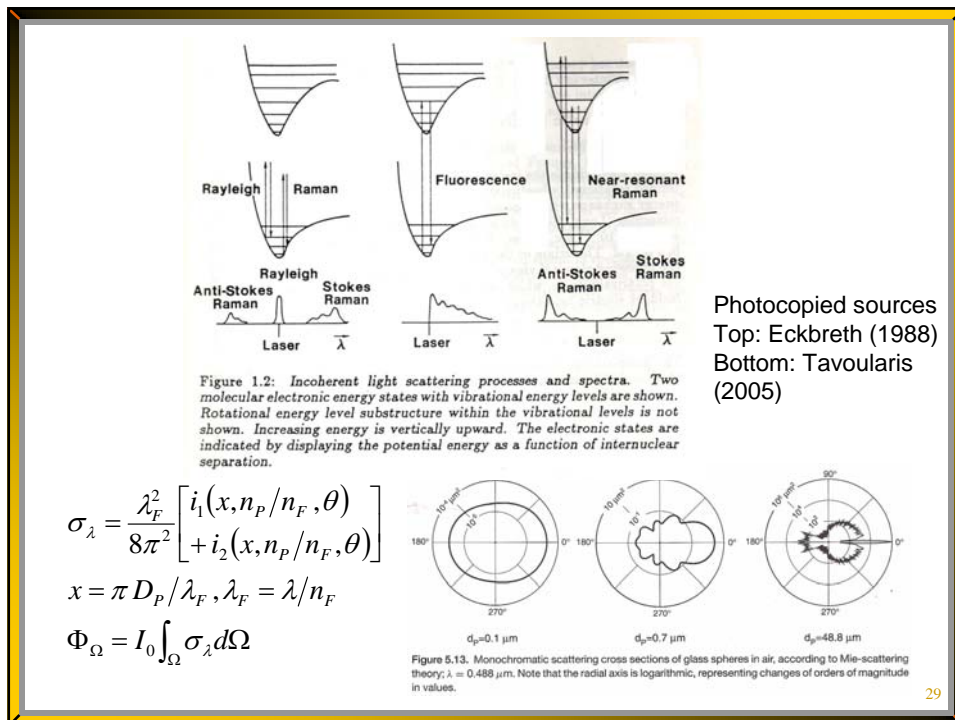

▪ Raman scattering

- *Spontaneous Raman* (SRS) effect ($\sim 10^{-14} - 10^{-12}$ s)
 - Measurement of temperature, species and concentration
 - Unique vibrational energy levels, not contaminated by incident light, detection for different molecules; low intensity ($10^{-5} - 10^{-2}$ lower than RS)
 - As $T \uparrow$, vibrational/rotational energy bands $\uparrow \rightarrow$ spectral overlapping
 - High-power (e.g. KrF excimer) laser; low λ preferred, $\sigma \propto \lambda^{-4}$
- *Near-resonant Raman* scattering (cross section enhanced by 6 orders)
 - Frequency tuned near (off) an electronic resonance of molecule, nearly instantaneous, insensitive to collisional quenching
- *Stokes transition*: photon emitted at lower energy than absorbed one
- *Anti-Stokes transition*: photon emitted at higher energy than absorbed

- Origin in terms of dipole moment and polarizability $\vec{p} = \alpha \epsilon_0 \vec{E}$
 $\alpha = \alpha_0 + \left(\frac{\partial \alpha}{\partial Q} \right)_0 Q \quad Q = Q_0 \cos \omega_v t \quad \text{e.g., in vibrational mode}$
 $\rightarrow \vec{p} = \left[\alpha_0 + \left(\frac{\partial \alpha}{\partial Q} \right)_0 Q_0 \cos \omega_v t \right] \epsilon_0 \vec{E}_0 \cos \omega_0 t$
 $= \alpha_0 \epsilon_0 \vec{E}_0 \cos \omega_0 t + \left(\frac{\partial \alpha}{\partial Q} \right)_0 \epsilon_0 \frac{Q_0 \vec{E}_0}{2} [\cos(\omega_0 - \omega_v) t + \cos(\omega_0 + \omega_v) t]$
- Indicating Rayleigh process, Stokes transition, anti-Stokes transition
- Raman: species specific and linearly proportional to number density
- CARS (coherent anti-Stokes Raman spectroscopy)
 - much stronger signal, not sensitive to soot
 - two monochromatic beams (by 1 tunable, 1 fixed lasers) $\nu_1, \nu_2 (< \nu_1)$
 - molecules with vibrational energy $\Delta \nu = \nu_1 - \nu_2 \rightarrow$ coherent, collinear beams $\nu_1 + \Delta \nu$ (anti-Stokes) and $\nu_2 - \Delta \nu$ (Stokes)

31

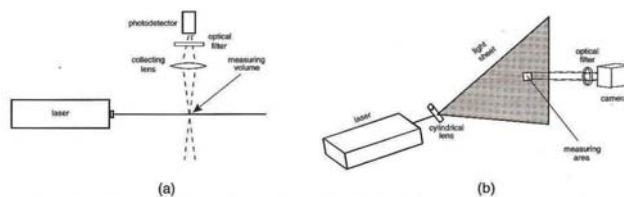

Figure 13.5. Sketches of optical arrangements for (a) local LIF and (b) PLIF.

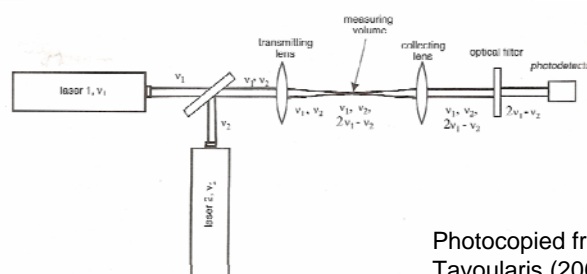

Figure 13.4. Sketch of a CARS system (adapted from Ref. 50).

Photocopied from
Tavoularis (2005)

32

- CARS: anti-Stokes region free of fluorescent interference
- More complicated spectra, limited sensitivity to species concentration
- At atmospheric pressure, CARS is restricted to major constituents, sensitivity capabilities similar to SRS; both are complimentary to LIFS which is capable of detecting flame radicals at trace, ppm, levels but not for major species due to spectral inaccessibility of electronic transitions

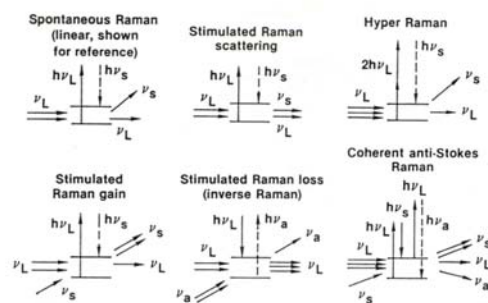

Figure 1.3: Survey of various nonlinear optical processes. Two different ro-vibrational states are shown. Upward facing arrows indicate photon absorption or conversion; downward facing arrows depict photon emission.

Photocopied from Eckbreth (1988)

33

▪ Fluorescence

- *Fluorescence*: time delay after absorption $\sim 10^{-10} - 10^{-5}$ s; transition between the same electronic spin states (multiplicity)
- *Phosphorescence*: time delay $\sim 10^{-4}$ s – hours; transition between different electronic spin states
- An uncertainty – *quenching* in fluorescence: with sufficient time for collisions of molecules to occur and photon energy to be converted to chemical reaction, dissociation, and ionization energies, before emission
- Other causes to fluorescence in addition to photon absorption: electron bombardment, heating/chemical reaction (*chemiluminescence*)
- Resonant/non-resonant(shifted) fluorescence: latter preferred, to allow isolation of fluorescence radiation from incident light & Mie scattering
- High intensity, independent of direction, randomly polarized

34

- Laser-induced fluorescence spectroscopy (LIF/LIFS)
 - Principal measurement of concentration in liquid and gas
 - For T : fluorescence quantum efficiency \downarrow with $T \uparrow$ (\sim linearly)
 - Type: local LIF vs. planar LIF (PLIF)
 - Qualitative and quantitative (limited by depletion, extinction, T sensitivity, pH sensitivity, spatial resolution, non-uniform illumination)
 - Use passive fluorescent seeding materials in non-reacting gases such as biacetyl which emits radiation in visible range
 - Mostly used in flames, with fluorescence given by radicals such as OH, CH, CO, and NO \rightarrow map chemical reactions
 - Produce strongest radiation signal from a single species
 - Excited by tunable, pulsed, dye and excimer lasers, visible/ultraviolet

35

A Case Study of Measuring Velocity and Species Concentration

- A study of bluff-body combustion field
 - Background
 - Experimental facility
- Measurements
 - Visual observation
 - Flow velocity field by LDV
 - Distribution of OH radicals by PLIF

36

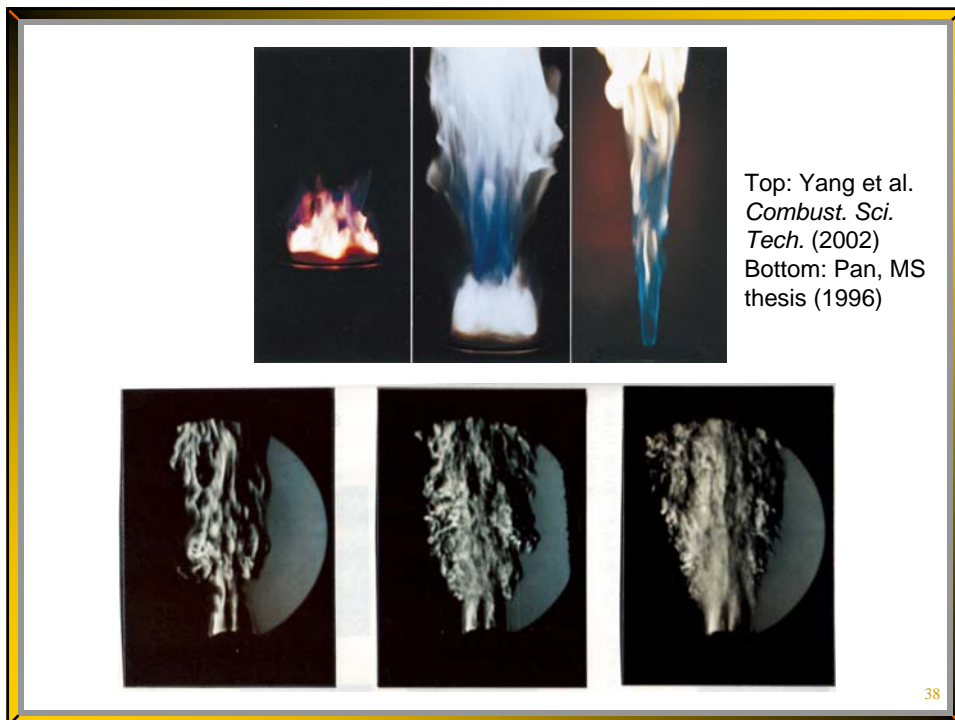
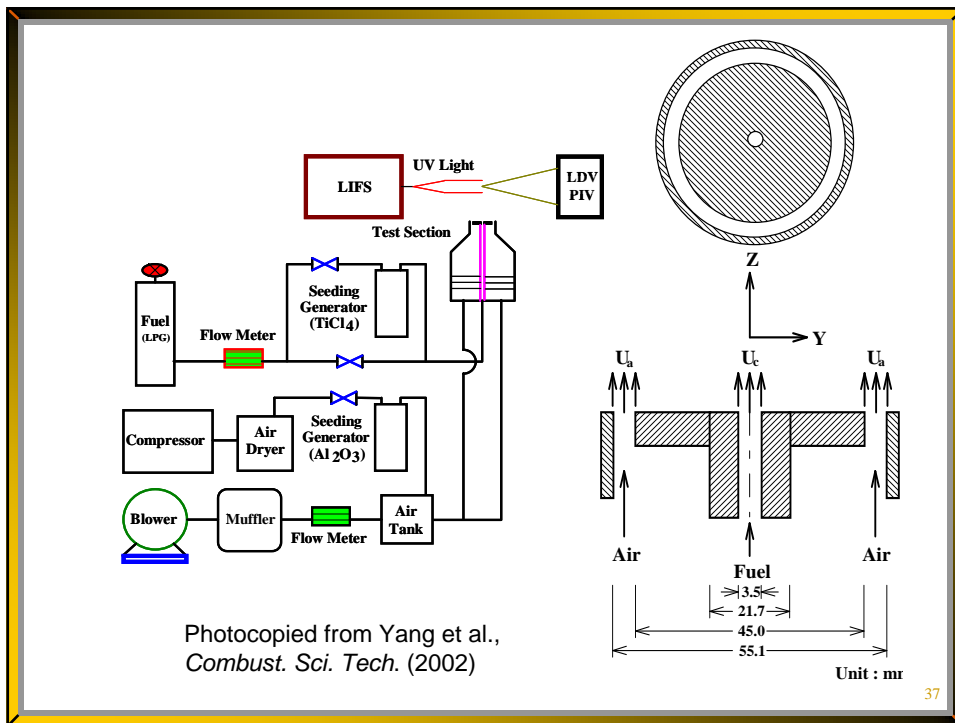

LDV arrangement and measurement

Photocopied from Yang et al.,
Combust. Sci. Tech. (2002)

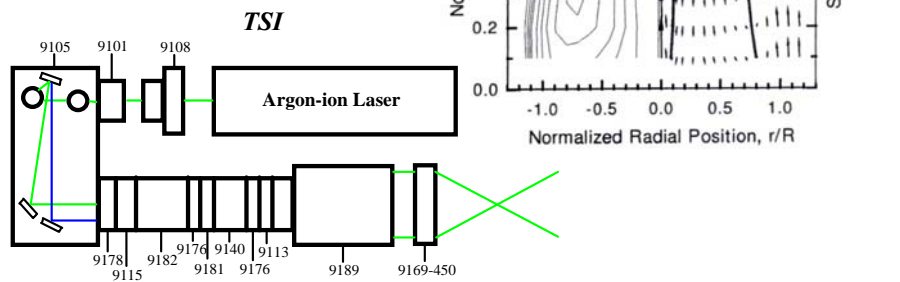

39

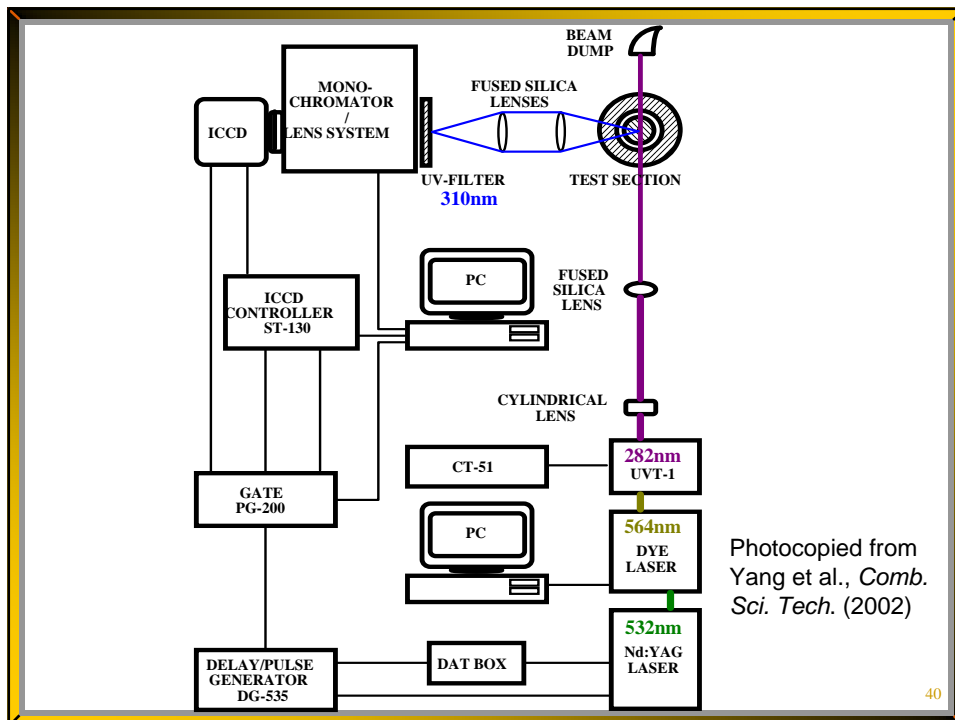

40

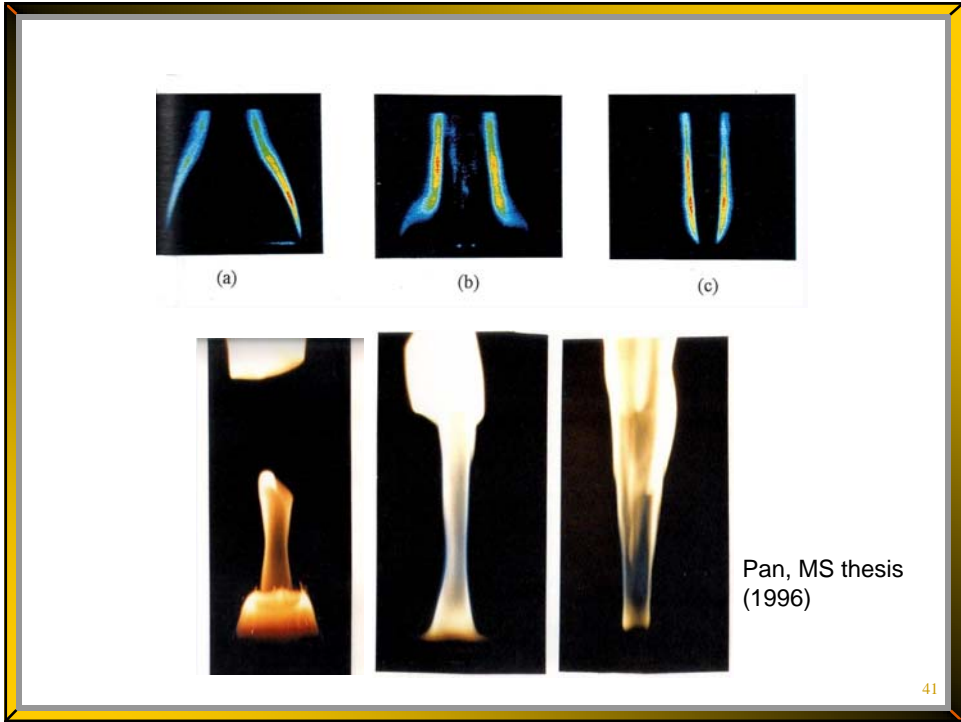

41

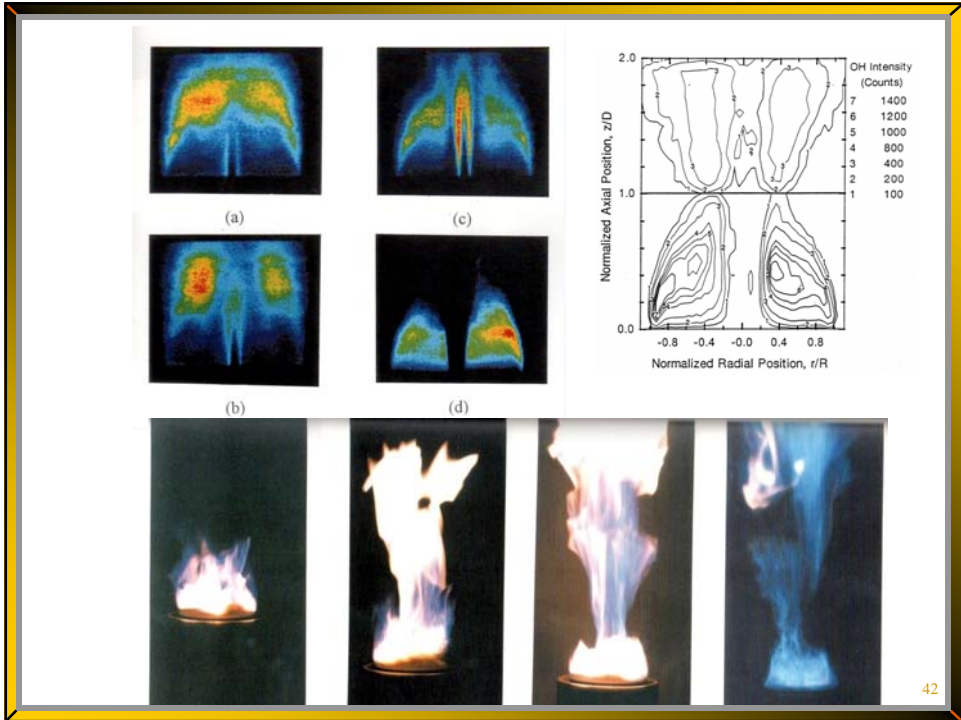

42

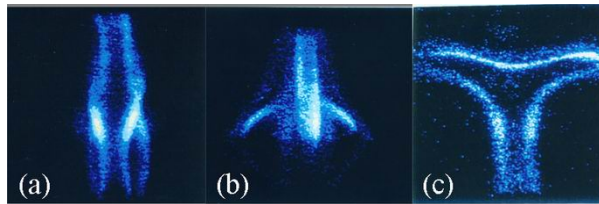
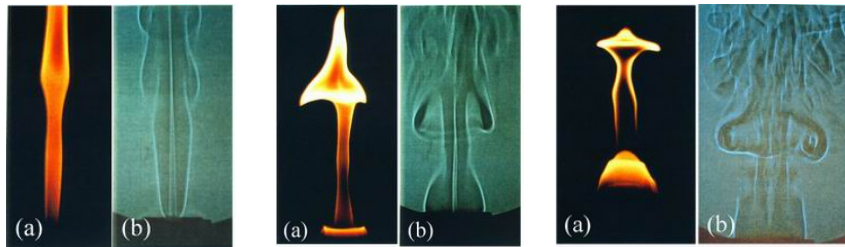

Pan, MS thesis (1996); also Pan et al., *Combust. Sci. Tech.* (2009)